

Quick Start Guide

UA-XVL810, UA-XVL1610, UA-XVR810



Before attempting to connect or operate this product,
please read these instructions carefully and save this manual for future use.

UVSUAV110-QG-A



© 2022 GeoVision, Inc. All rights reserved.

Under the copyright laws, this manual may not be copied, in whole or in part, without the written consent of GeoVision.

Every effort has been made to ensure that the information in this manual is accurate. GeoVision, Inc. makes no expressed or implied warranty of any kind and assumes no responsibility for errors or omissions. No liability is assumed for incidental or consequential damages arising from the use of the information or products contained herein. Features and specifications are subject to change without notice.

GeoVision, Inc.
9F, No. 246, Sec. 1, Neihu Rd.,
Neihu District, Taipei, Taiwan
Tel: +886-2-8797-8377
Fax: +886-2-8797-8335
<http://www.geovision.com.tw>

Trademarks used in this manual: *GeoVision*, the *GeoVision* logo and *GV* series products are trademarks of GeoVision, Inc. *Windows* is the registered trademark of Microsoft Corporation.

September 2022

Scan the following QR codes for product warranty and technical support policy:



[Warranty]



[Technical Support Policy]

Contents

1. Introduction	1
1.1 Packing List	1
1.2 Overview	2
1.2.1 UA-XVL810 Front Panel	2
1.2.2 UA-XVL810 Rear Panel	3
1.2.3 UA-XVL1610 Front View	4
1.2.4 UA-XVL1610 Rear View	5
1.2.5 UA-XVR810 Front View	6
1.2.6 UA-XVR810 Rear View	7
2. Installation	8
2.1 HDD Installation	8
2.2 Connection Diagram	9
2.3 Power Supply Connection	9
3. Getting Started	10
3.1 Start Wizard	10
3.1.1 Start Wizard	10
3.1.2 Connecting IP Cameras	10
3.2 Live View Overview	12
3.2.1 Main Window	12
3.2.2 Task Menu Bar	14
3.2.3 Camera Quick Toolbar	14
4. Remote Access via Web Client	16
4.1 Basic System Requirements	16
4.2 Looking Up the Dynamic IP Address	17
4.3 Web Client Manager Live Interface	18
5. Upgrading Firmware	20

1. Introduction

Welcome to the UA-XVL1610, UA-XVR810 Quick Start Guide. In the following sections, you will learn about the basic installations and configurations. For more details, see *UA-XVL810, XVL1610, UA-XVR810 User's Manual*.

1.1 Packing List

- UA-XVL810 / UA-XVL1610 /
UA-XVR810
- 3.5" HDD screw Kit
- 2.5" HDD screw kit
- USB mouse
- Power adapter (DC 12V, 2A, 24W)
- Download guide

1.2 Overview

1.2.1 UA-XVL810 Front Panel



Item	Description
Power LED	Show constant green when power is supplied.
HDD LED	Blink red when the HDD is writing or reading data. No LED when no HDD is installed.
USB port	Connect the supplied mouse or USB flash memory.

1.2.2 UA-XVL810 Rear Panel



Item	Description
Audio Input	Connect with audio input signals, RCA port.
CVBS	Connect to your TV or monitor, BNC port.
Audio Output	Audio signal output, RCA port.
Video Input	Connect with video input devices, BNC port.
HDMI	Connect to your digital TV or monitor with HDMI input.
VGA	Connect to your TV or a monitor with VGA input.
LAN	Connect to your home network.
USB port	Connect the supplied mouse or USB flash memory.
Reset	Load default settings of the DVR. Note: The Reset button is below the USB port. Poke the Reset button to load default settings.
RS-485	Connect to PTZ devices.
Power	Connect to the supplied power adaptor.

1.2.3 UA-XVL1610 Front View



Item	Description
Power LED	Show constant green when power is supplied.
HDD LED	Blink red when the HDD is writing or reading data. Show no LED when no HDD is installed.
USB port	Connect the supplied mouse or USB flash memory.

1.2.4 UA-XVL1610 Rear View



Item	Description
Video Input	Connect with video input devices, BNC port.
Audio Input	Connect with audio input signals, RCA port.
Audio Output	Audio signal output, RCA port.
VGA	Connect to your TV or a monitor with VGA input.
HDMI	Connect to your digital TV or monitor with HDMI input.
LAN	Connect to your home network.
USB port	Connect the supplied mouse or USB flash memory.
Reset	Load default settings of the DVR. Note: The Reset button is below the USB port. Poke the Reset button to load default settings.
Power	Connect to the supplied power adaptor.
RS-485	Connect to PTZ devices.
Sensor & Alarm	Optional. Connect to external sensor & alarm devices.
Power Switch	Turn on / off power supply.

1.2.5 UA-XVR810 Front View



Item	Description
Power LED	Show constant green when power is supplied.
HDD LED	Blink red when the HDD is writing or reading data. No LED when no HDD is installed.
USB port	Connect the supplied mouse or USB flash memory.

1.2.6 UA-XVR810 Rear View



Item	Description
CVBS	Connect to your TV or monitor, BNC port.
Audio Output	Audio signal output, RCA port.
Video Input	Connect with video input devices, standard BNC port.
Audio Input	Connect with audio input signals, RCA port.
Reset	Load default settings of the DVR. Note: The Reset button is next to the HDMI port. Poke the Reset button to load default settings.
VGA	Connect to your TV or a monitor with VGA input.
HDMI	Connect to your digital TV or monitor with HDMI input.
LAN	Connect to your home network.
USB port	Connect the supplied mouse or USB flash memory.
Power	Connect to the supplied power adaptor.
RS-485	Connect to PTZ devices.
Sensor & Alarm	Optional. Connect to external sensor & alarm devices.
Power Switch	Turn on / off power supply.

2. Installation

2.1 HDD Installation

Follow the instructions below to install the HDD in the DVR for video data storage.

Caution: DO NOT install or remove the hard drive while the power is turned ON.

Note:

1. The DVR supports 3.5" and 2.5" SATA HDD of up to 8 TB only.
 2. The following procedures are for reference only. The practical operation may be different depending on the model you purchased.
-

HDD Installation:

- (1) Cut power firstly. Unscrew both sides and rear panel to open the upper cover.

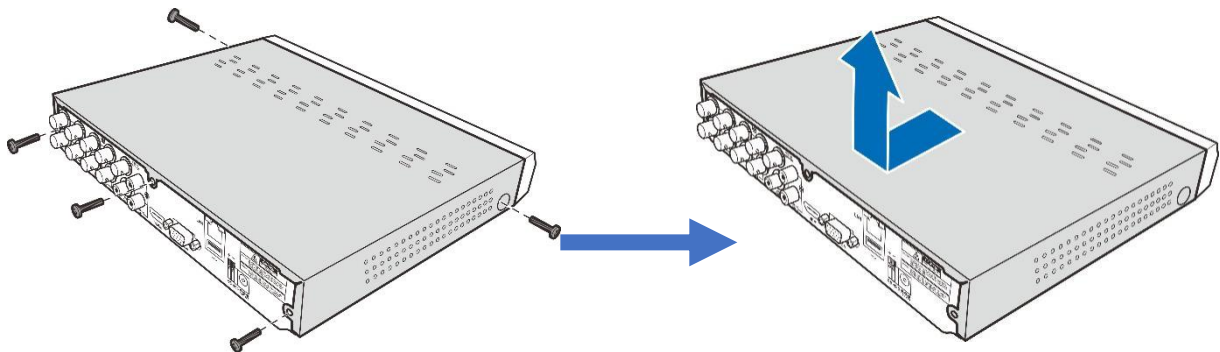

- (2) Connect the data and power cables to the HDD and place the HDD on the DVR case. Carefully flip the DVR case and secure the HDD to the DVR with screws.

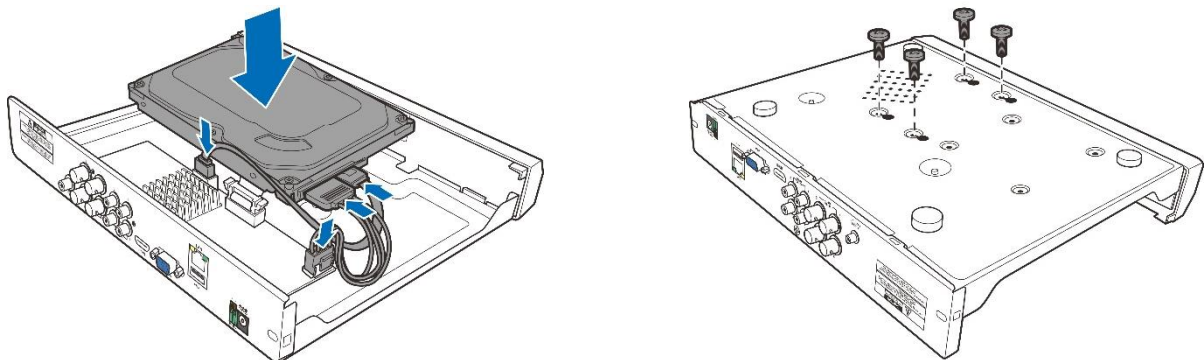

2.2 Connection Diagram

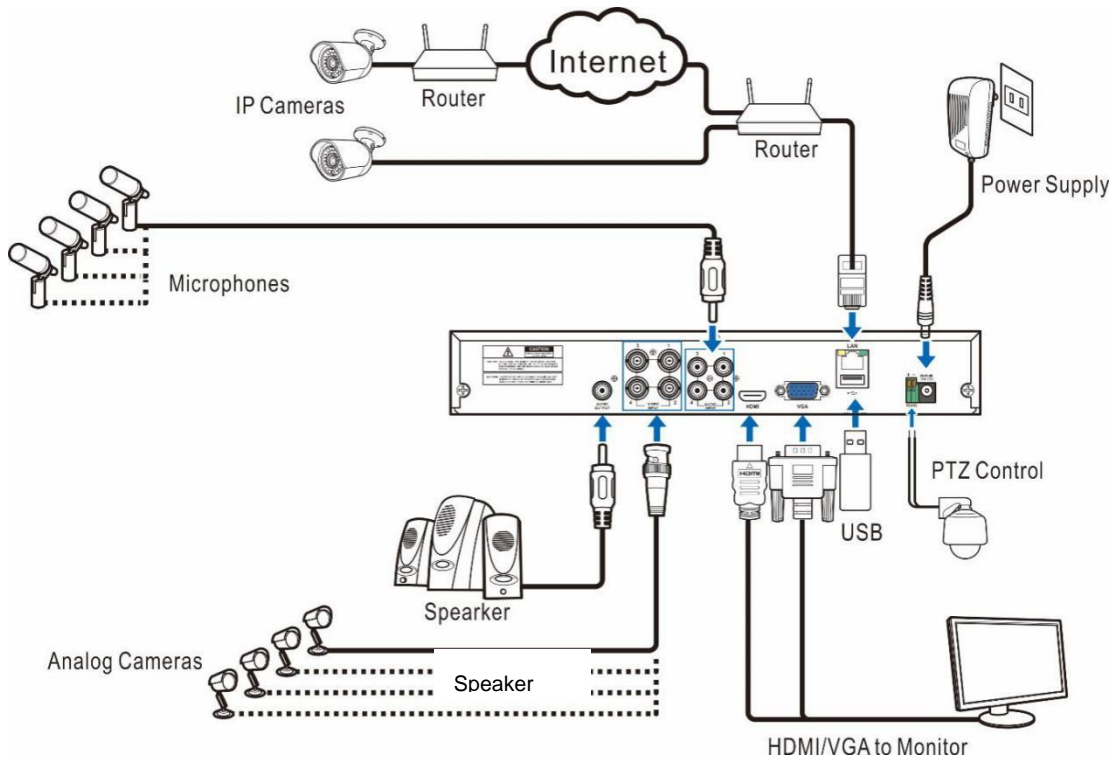

2.3 Power Supply Connection

Caution: Use only the supplied power adapter of the DVR.

Connect one end of the power adapter to the power connector on the back of the DVR. Plug the other end of the power adapter into the wall outlet.

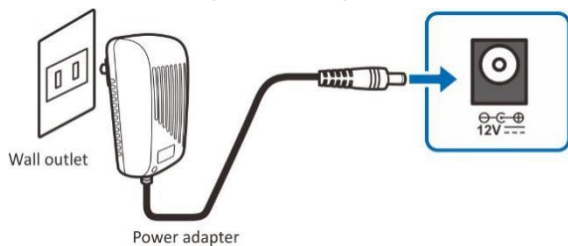

For specific models, press the **Power Switch** to turn on the power.

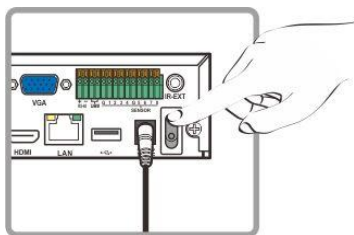

3. Getting Started

3.1 Start Wizard

3.1.1 Start Wizard

Click **Start Wizard** to proceed to the next step.

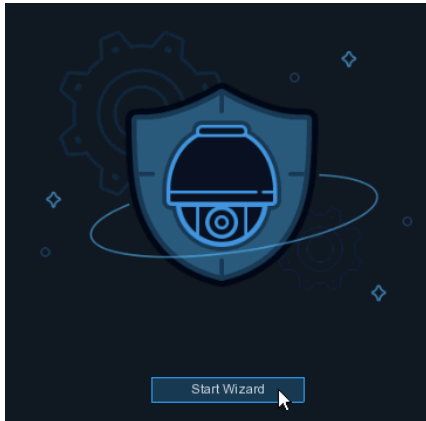

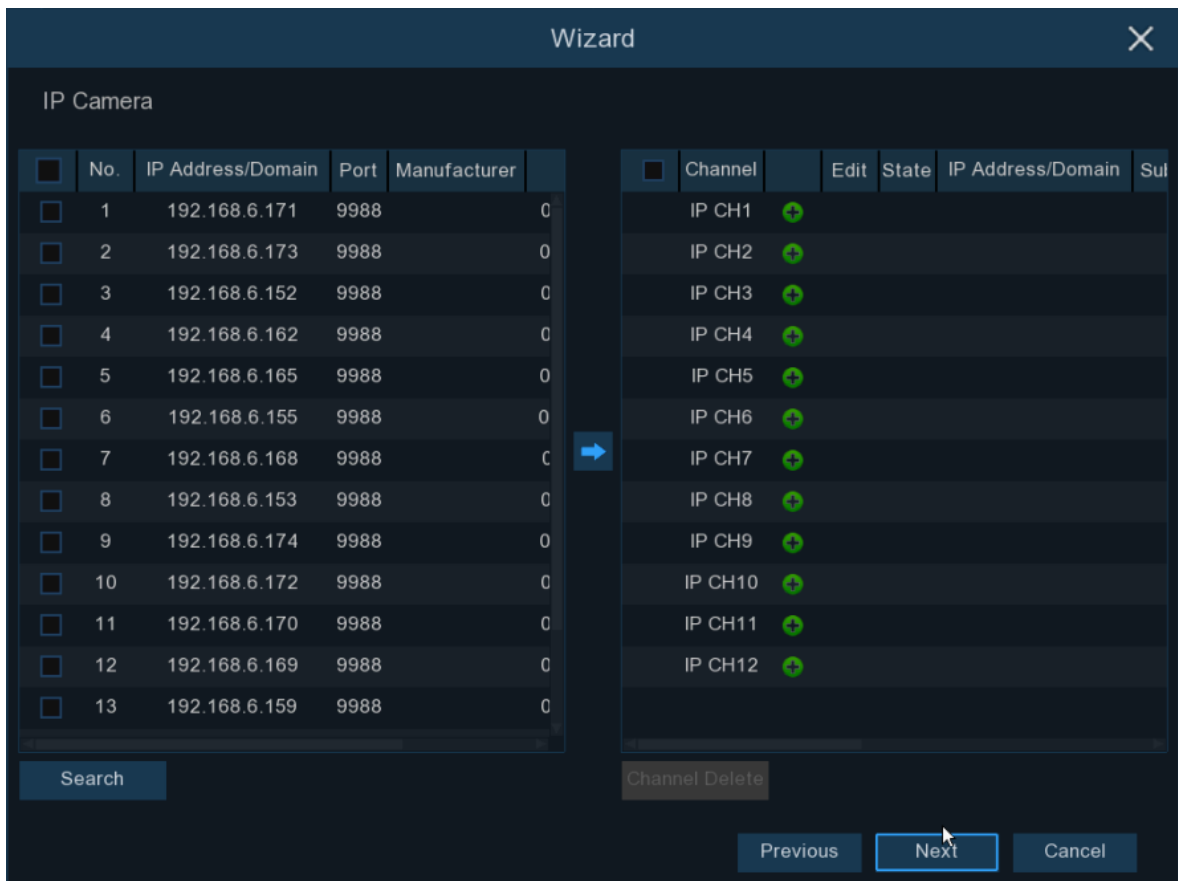

3.1.2 Connecting IP Cameras

After finishing setting **Network Configuration** and **Date and Time**, this page appears.

A screenshot of a "Wizard" window titled "IP Camera". The window is divided into two main sections. The left section contains a table with columns: No., IP Address/Domain, Port, and Manufacturer. The right section contains a table with columns: Channel, Edit, State, IP Address/Domain, and Sul. At the bottom, there are buttons for "Search", "Channel Delete", "Previous", "Next", and "Cancel".

No.	IP Address/Domain	Port	Manufacturer
1	192.168.6.171	9988	
2	192.168.6.173	9988	
3	192.168.6.152	9988	
4	192.168.6.162	9988	
5	192.168.6.165	9988	
6	192.168.6.155	9988	
7	192.168.6.168	9988	
8	192.168.6.153	9988	
9	192.168.6.174	9988	
10	192.168.6.172	9988	
11	192.168.6.170	9988	
12	192.168.6.169	9988	
13	192.168.6.159	9988	

Channel	Edit	State	IP Address/Domain	Sul
IP CH1	+			
IP CH2	+			
IP CH3	+			
IP CH4	+			
IP CH5	+			
IP CH6	+			
IP CH7	+			
IP CH8	+			
IP CH9	+			
IP CH10	+			
IP CH11	+			
IP CH12	+			

Click **Search** to search IP cameras in the same network. Choose the IP camera(s) you want to add, and then click  icon to add to the DVR. Or, click  button to manually add individual IP camera to a single channel.

- **IP Address/Domain:** IP address or domain name of the IP camera.
- **Alias:** Name of the IP camera.
- **Port:** Port of the IP camera. It is set to 80 by default. Modify it if necessary.
- **Protocol:** Choose the protocol of the IP camera from the dropdown menu.
 - Select **Onvif** for UA-B20004F / UA-B40004F / UA-B4000VF-S / UA-D20002F / UA-D40002F / UA-D4000VF-S / UA-R40002F-SA / GV-IP cameras
 - Select **Private** for UA-B580F3 / UA-R500F2 / UA-R560F2 / UA-R580F2 / UA-R800F2
- **User Name:** User Name of the IP camera.
- **Password:** Password of the IP camera.

Note:



1. The system fills in the ID and password using admin/admin by default. Make sure to enter the correct ID and password of the IP cameras when adding them to the DVR.
 2. The default password is 123456 for the following IP camera models: UA-B20004F / UA-B40004F / UA-B4000VF-S / UA-D20002F / UA-D40002F / UA-D4000VF-S / UA-R40002F-SA. To modify the password on the camera's Web interface, refer to [Network Cameras User Manual](#) for details.
-

3.2 Live View Overview

3.2.1 Main Window



No.	Name	Description
1	Camera Title	<p>A-: This indicates that the camera connected is an AHD camera.</p> <p>T-: This indicates that the camera connected is a TVI camera.</p> <p>C-: This indicates that the camera connected is a CVI camera.</p> <p>IP: This indicates that the camera connected is an IP camera.</p>
2	Status Icon	<p> This indicates that the DVR is currently recording.</p> <p> This icon appears when the camera has detected motion.</p> <p> The icon indicates that the external I/O alarm device is triggered.</p> <p> This icon indicates that the HDD is in error to work.</p> <p> This icon indicates the HDD is unformatted.</p> <p> This icon indicates the HDD is full.</p> <p> This icon indicates the HDD is read-only.</p>

3	Camera Quick Toolbar	Left-click on the screen to quickly access the camera's toolbar. Refer to <i>3.2.3 Camera Quick Toolbar</i> in the <i>Quick Start Guide</i> for details.
4	Start Menu	admin: To switch user. Search: Search & Playback. Setup: DVR System Setup. Lock Screen: Lock and unlock screen. Shutdown: Shutdown, reboot, and log out the system.
5	Task Menu Bar	Locates at the bottom of the live view screen. Refer to <i>3.2.2 Task Menu Bar</i> in the <i>Quick Start Guide</i> for details.
6	System Date and Time	Displays the system's date and time.
7	OSD	VIDEO LOSS: The analog camera is disconnected. No Camera: IP camera is disconnected. Decoding Failed: The DVR doesn't support the current IP camera compression standard. Change the compression standard to H.264.  Click to open Quick Add menu to add IP camera.  Click to edit the current IP camera.

For more details, see *4.2 Live View Screen Overview* in *UA-XVL810, XVL1610, UA-XVR810 User's Manual*.

3.2.2 Task Menu Bar





 Click to open the **Start Menu**.

 Click to choose different layouts for live view.

 **More Layout:** Click to choose more layouts for live view.

 **Auto SEQ:** Click to start viewing channels in a sequence.

 **Playback:** You can choose to play the latest recording for all channels from the beginning of the day, or you can choose the playback from the latest 5s, 10s, 30s, 1Min, 5Min.

 **Audio:** Click to adjust audio volume.

 **Preview Policy:** Click to switch among real-time, balanced, or smooth view. This function only effects the live view video quality by bitrate and frame rate without impacting the recording quality.

 **Manual:** To start or stop **Manual Record** and **Manual Alarm**.

 **System:** To view system information, channel information, record info, and network state.





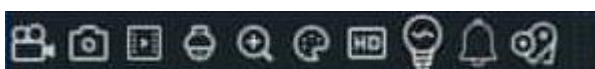











 This icon appears if the network is disconnected.

3.2.3 Camera Quick Toolbar



 Click to manually record the channel. If the manual recording is in process, the icon will be in red color. Click one more time to stop manual record.

 Click to save a snapshot of the current camera image. **Manual Capture** must be enabled to use this feature.

-  Click to play the last 5 minutes of recording of this channel.
-  Click to enter PTZ control panel.
-  Click to zoom-in the channel. When the  icon appears, press and hold the left button of your mouse to drag the area you want to zoom in.
-  Click to adjust the image color of the channel. You can adjust the HUE, BRIGHT, CONTRAST & SATURATION of the image.
-  Click to switch main/sub stream
-  Click to enable/disable white light alarm. Note that this menu won't change the white light setting parameter.
-  Click to manually record the channel. If the manual recording is in process, the icon will be in red color. Click one more time to stop manual record.
-  Click to save a snapshot of the current camera image. **Manual Capture** must be enabled to use this feature.
-  Click to play the last 5 minutes of recording of this channel.
-  Click to enter PTZ control panel.
-  Click to zoom-in the channel. When the  icon appears, press and hold the left button of your mouse to drag the area you want to zoom in.
-  Click to adjust the image color of the channel. You can adjust the HUE, BRIGHT, CONTRAST & SATURATION of the image.
-  Click to switch main/sub stream
-  Click to enable/disable white light alarm. Note that this menu won't change the white light setting parameter.

4. Remote Access via Web Client

Use the **Web Client** to remotely access your DVR at any time via a PC. Before you access the **Web Client**, ensure that your PC's system meets the basic requirements and that the network settings of the DVR are configured properly.

4.1 Basic System Requirements

Item	Minimum	Recommended
CPU	Intel® Core™ i5 CPU	Intel® Core™ i5 CPU or higher
RAM	4G or more	8G or more
Hard Drive	500G or more	1000G or more
Display RAM	2G or more	4G or more
Display Resolution	1280*1024	1920*1080
OS	Windows 7 or above Mac OS X® 10.9 or above	
DirectX	DirectX 11	
Direct3D	Acceleration Function	
Ethernet Adapter	10/100/1000M Ethernet Adapter	
IE	10/11	
Mozilla Firefox	V52 or later	
Google Chrome	V57 or later	
Mac Safari	V12.1 or later	
Edge	V79 or later	

4.2 Looking Up the Dynamic IP Address

By default, when the DVR is connected LAN with DHCP server, it is automatically assigned with a dynamic IP address. Follow the steps below to look up its IP address.

1. Download and install the **UVS Device Utility** program [here](#).
2. On the UVS Device Utility window, click **Search** to search for the devices connected in the same LAN.
3. Find the device with its Mac Address and click on its IP address.

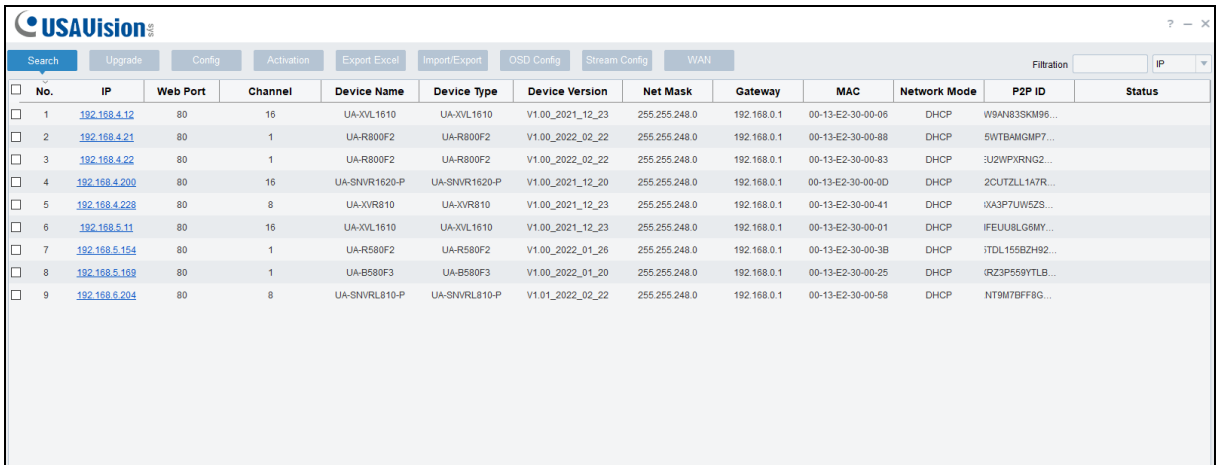

No.	IP	Web Port	Channel	Device Name	Device Type	Device Version	Net Mask	Gateway	MAC	Network Mode	P2P ID	Status
1	192.168.4.12	80	16	UA-XVL1610	UA-XVL1610	V1.00_2021_12_23	255.255.248.0	192.168.0.1	00-13-E2-30-00-06	DHCP	W9AN83KM96...	
2	192.168.4.21	80	1	UA-R800F2	UA-R800F2	V1.00_2022_02_22	255.255.248.0	192.168.0.1	00-13-E2-30-00-88	DHCP	5WTBAMGMP7...	
3	192.168.4.22	80	1	UA-R800F2	UA-R800F2	V1.00_2022_02_22	255.255.248.0	192.168.0.1	00-13-E2-30-00-83	DHCP	3U2WPKRNG2...	
4	192.168.4.200	80	16	UA-SNVR1620-P	UA-SNVR1620-P	V1.00_2021_12_20	255.255.248.0	192.168.0.1	00-13-E2-30-00-0D	DHCP	2CUTZLL1A7R...	
5	192.168.4.228	80	8	UA-XVR810	UA-XVR810	V1.00_2021_12_23	255.255.248.0	192.168.0.1	00-13-E2-30-00-41	DHCP	WA3P7UW5ZS...	
6	192.168.5.11	80	16	UA-XVL1610	UA-XVL1610	V1.00_2021_12_23	255.255.248.0	192.168.0.1	00-13-E2-30-00-01	DHCP	IFEU8L6GMY...	
7	192.168.5.154	80	1	UA-R580F2	UA-R580F2	V1.00_2022_01_26	255.255.248.0	192.168.0.1	00-13-E2-30-00-3B	DHCP	ITDL155BZH92...	
8	192.168.5.169	80	1	UA-B580F3	UA-B580F3	V1.00_2022_01_20	255.255.248.0	192.168.0.1	00-13-E2-30-00-25	DHCP	GRZ3P559YTLB...	
9	192.168.6.204	80	8	UA-SNVR1610-P	UA-SNVR1610-P	V1.01_2022_02_22	255.255.248.0	192.168.0.1	00-13-E2-30-00-58	DHCP	NT9M7BF8G...	

4. The login web page appears.

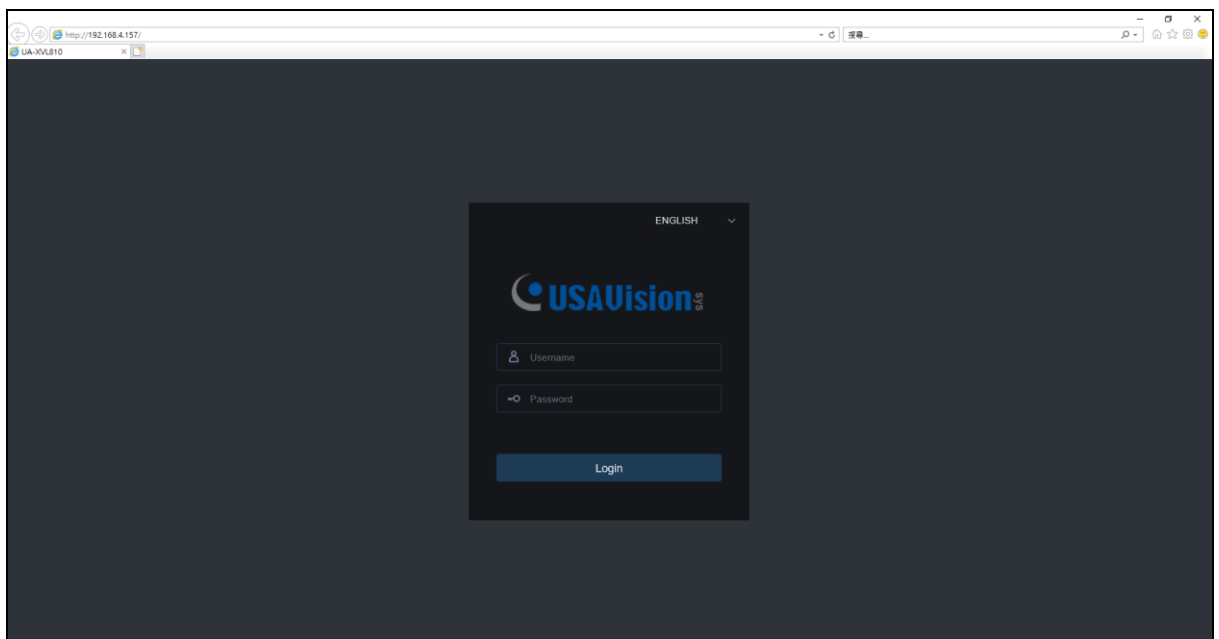

4.3 Web Client Manager Live Interface

Once you log in the Web Client Manager interface, you will see the live view as shown below.



No.	Name	Description
1	Channel List	<p>Click button to display the Channel List. Click button to hide the Channel List.</p> <p> Play. Turn the Live video stream on / off. The button is in blue color if the live video streaming is on.</p> <p> Record. Click to start manually recording live streaming video. Click again to stop recording. Manual recordings are saved to your computer. While in recording, the button is in blue color.</p> <p> Capture. Click to save a snapshot of the current live display to your computer.</p> <p> Bitrate. Set camera to use mainstream, sub-stream, or mobile stream video settings. Mobile stream is available for IP channels only.</p>

2	Live View Stream Options	<p>Mainstream: View all live videos using high-quality mainstream video settings.</p> <p>SubStream: View all live videos using middle-quality sub-stream video settings.</p> <p>MobileStream: View all live video using lower-quality mobile stream video settings to conserve bandwidth. Available for IP channels only.</p>
3	Main Menus	<p>Live: View live video from cameras.</p> <p>Playback: View recorded video which is saved in the DVR's HDD.</p> <p>Remote Setting: Access functions of the DVR setting menus.</p> <p>Local Settings: Set download locations for recordings and snapshots taken using Web Client, and choose file type for video files.</p>
4	Information	Hover over to see system details.
5	Exit	Click to close the Web Client Manager.
6	Color	Click to display or hide the color controls.
7	PTZ Setting	<p>Click to display or hide the PTZ controls for using PTZ cameras.</p> <p>Refer to <i>7.3.1 Live Interface</i> in <i>UA-XVL1610, UA-XVR810 User's Manual</i> for details.</p>
8	Live View Control Buttons	Click to configure live view controls.
9	Navigation	<p>Shows current page number for the channels shown on screen.</p> <p>Use the arrow keys to switch between pages.</p>
10	Page View	Click to select the number of channels appear on screen at a time.
11	Manual Alarm	The external alarm of each channel can be triggered manually.

5. Upgrading Firmware

You can upgrade the firmware on the device remotely through **UVS Device Utility**. Follow the instructions below.

1. Download and install the **UVS Device Utility** program [here](#).
2. On the UVS Device Utility window, click **Upgrade** and check the box of the device you wish to upgrade the firmware on. Optionally, check the corresponding boxes to upgrade the firmware on several devices at a time.

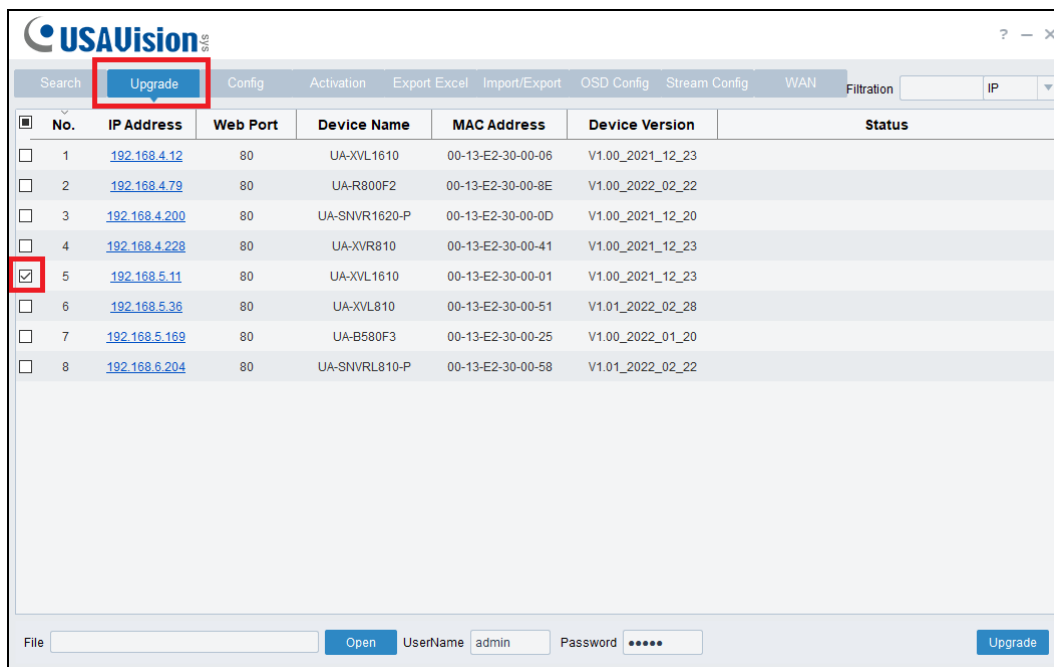

3. Click **Open** to locate the firmware file saved at your local computer.
4. Type the username and password of the device.
5. Click **Upgrade** to process the upgrade.

Note: To upgrade the firmware for UA-XVL810 V1.01 on the Web interface or on UVS Device Utility, make sure the output resolution is set to **1024 x 768**.
